

blu'therm 20

liquid

Without drip pan Art.-no. 4000587

With drip pan Art.-no. 4000591

Original – User manual

Art.-no. 4000587

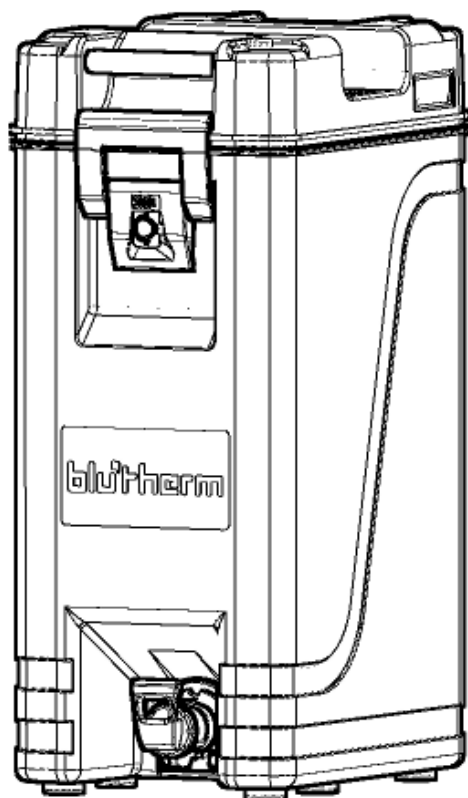

Art.-no. 4000591

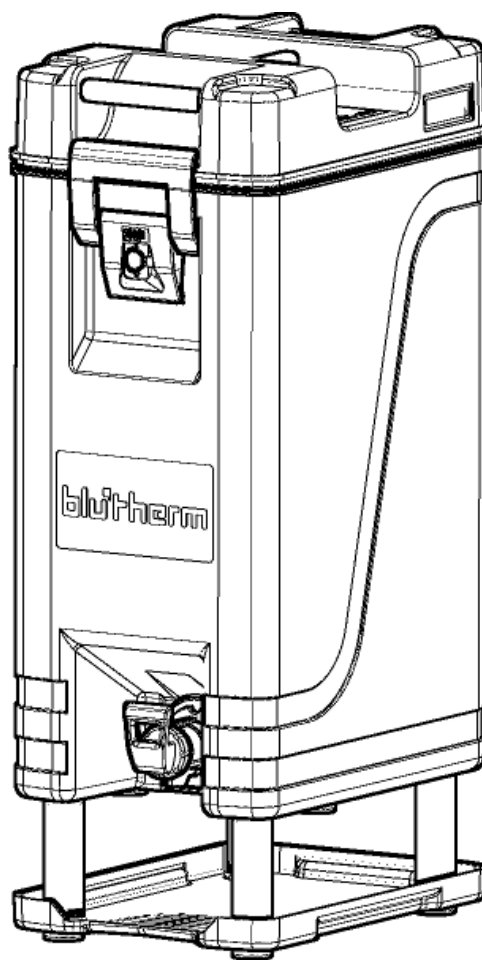

Beverage transport containers for the transportation of warm and cold beverages

• Use and explanation

Proper handling

Remove all removable parts:

- Cover
- Sealing ring for cover

- 20°C to + 100°C

- Tap part
- Outlet head
- Sealing ring for outlet head

• Cleaning

< + 130°C

- Clean all the removable parts in the dishwasher, all small parts must be put into a basket (dish washer temperature < + 130°C).
- For cleaning we recommend the use of etolit 3000 or 8000.

- **Storage**

The containers must be correctly stacked on top of each other and must be kept in clean, dry rooms.

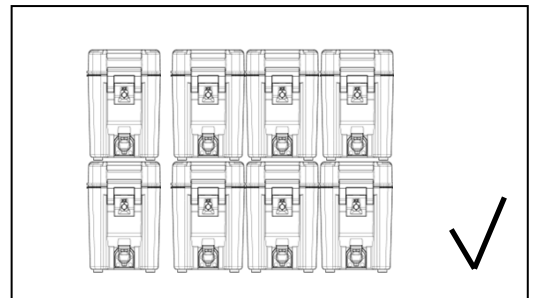
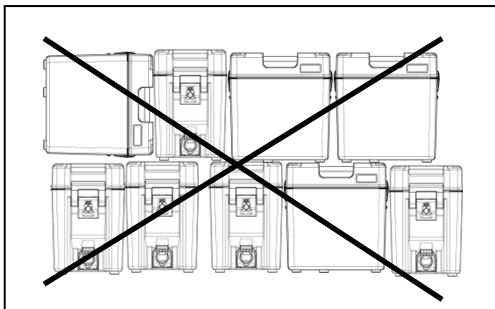

- **Transportation**

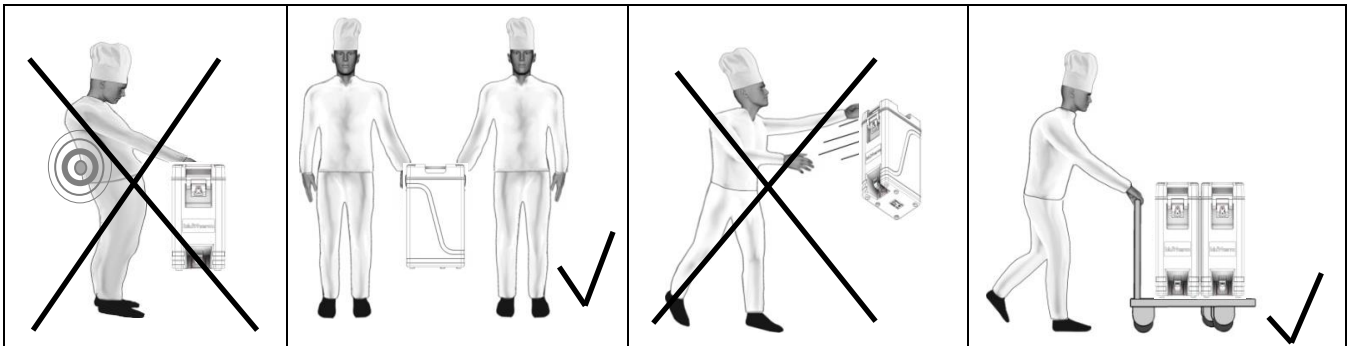

- **Disassembly of the clip closure Art.-no. 8002625**

	<p>Remove the sealing plugs of the screws with a pointed object (plugs will be destroyed).</p>
	<p>Please remove the screws with help of a screwdriver.</p>
	<p>The clip closure can now be removed.</p>

• Disassembly and assembly of the outlet

	<p><u>Disassembly :</u></p> <p>Turn the outlet head unit counterclockwise by 90°</p>
	<p><u>Disassembly:</u></p> <p>Unscrew the outlet head and tap part counterclockwise and pay attention to the sealing ring.</p>
	<p><u>Assembly:</u></p> <p>Place the sealing ring in the tap part and screw the outlet head together counterclockwise.</p>
	<p><u>Assembly:</u></p> <p>Turn the outlet head unit clockwise by 90°.</p>

Modification: neu ventilation

• Spare parts for Art.-no. 4000587

1 x 8000330
1 x 8003495
1 x 664100486
1 x 664202279
1 x 8003496
1 x 664202310

2 x 8002625
4 x 8004945
4 x 8001742

1 x 8004944
1 x 8002797
1 x 8004942

6 x 8002462
6 x 8002486
6 x 8001027

• Optional additional parts – Drip pan

4 x 8002660
1 x 664100833
4 x 8002462
4 x 8002495
4 x 8001027

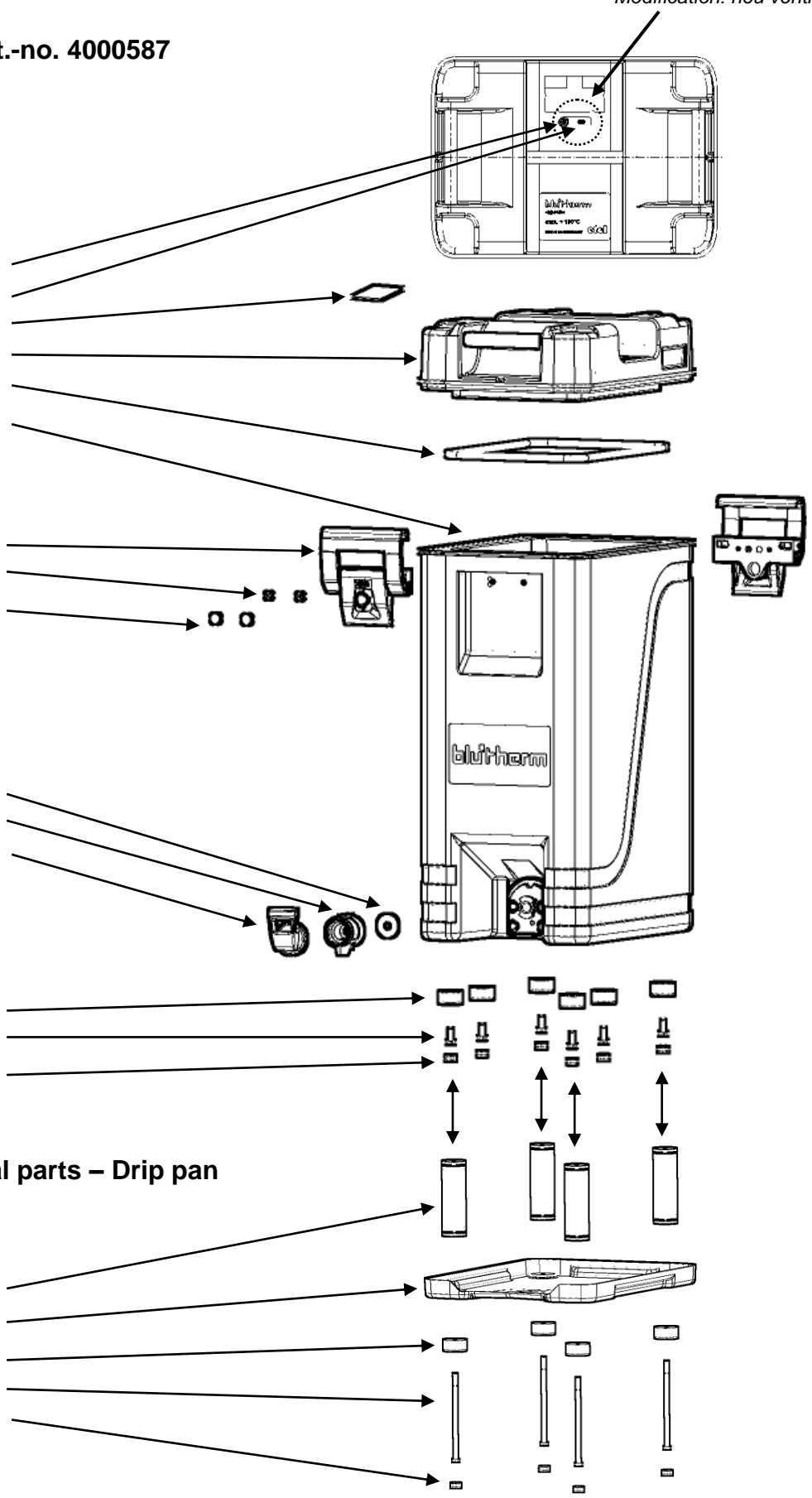

• **Disassembly and assembly of the drip pan**

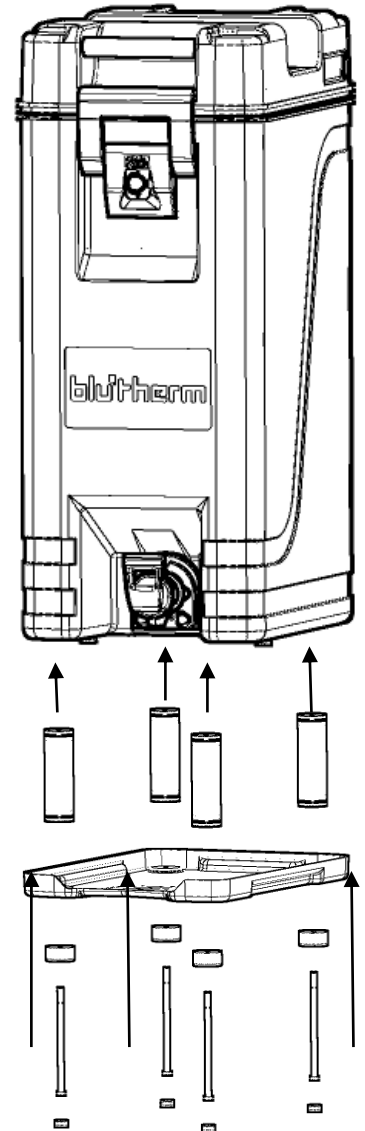
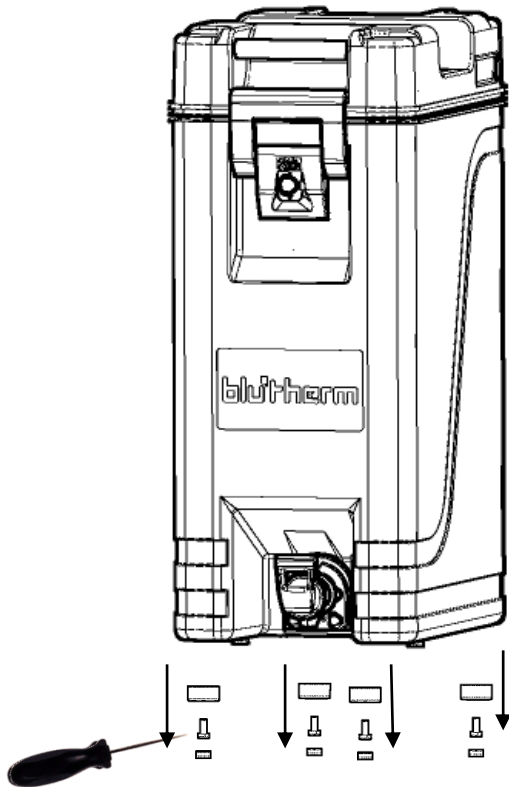

Remove the 4 Plugs Art.-no. 8001027 for the screw holes with a pointed object (plugs will be destroyed). Please turn the 4 screws Art.-no. 8002486 out with the help of a screwdriver and put in the 4 stacking fittings Art.-no. 8002462.

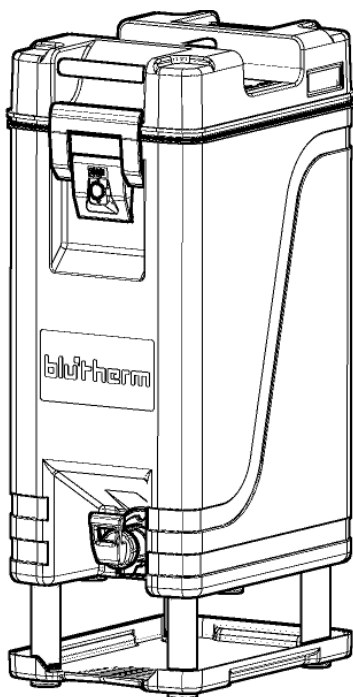

Order of the assembly of the drip pan:

- 4 x 8002495 – Allen screw M5x120
- 4 x 8002462 – Stacking fittings
- 1 x 664100833 – Drip pan
- 4 x 8002660 – Distance piece
- 4 x 8001027 – Plug for the screw hole

• **Technical data**

Main dimensions and weight

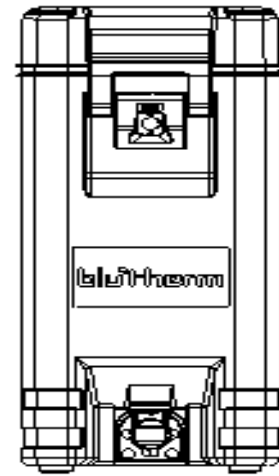
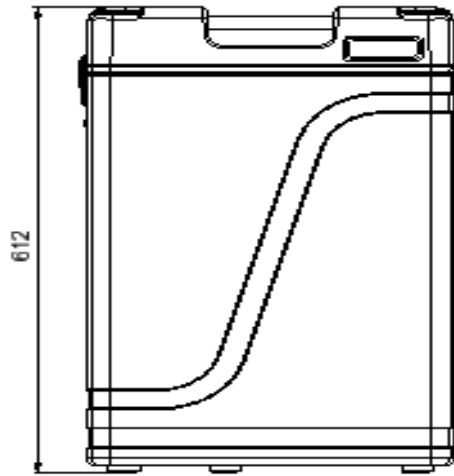
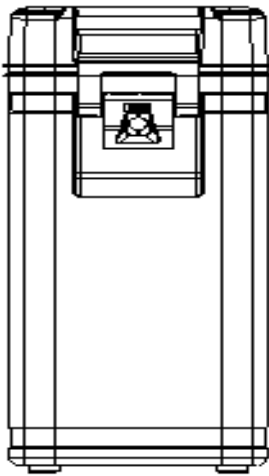

Art.-no.4000587
Weight = 6,0 kg

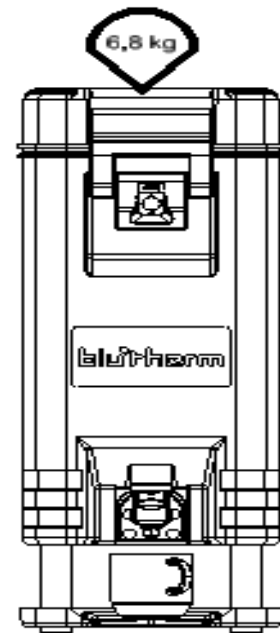
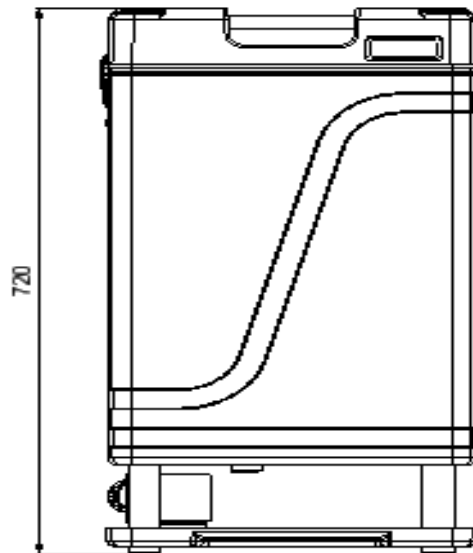
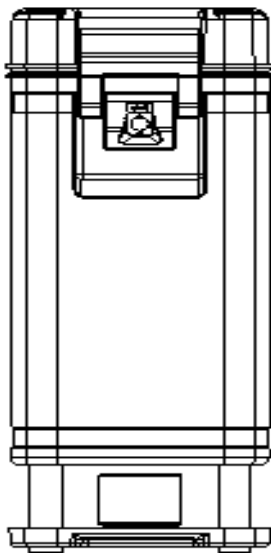
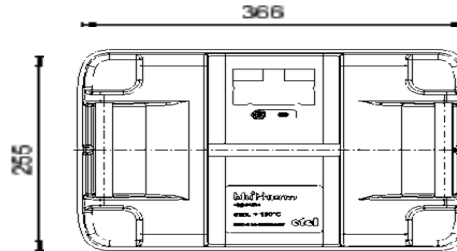

Art.-no. 4000591
Weight = 6,8 kg

• **Producer**

etol Eberhard Tripp GmbH • Allerheiligenstraße 12 • 77728 Oppenau • Germany
T. + 49 (0) 7804 410 www.bluline.de - info.bluline@etol.de

Powerful products for commercial kitchens.
www.etol.de



etol Eberhard Tripp GmbH • Allerheiligenstraße 12 • 77728 Oppenau • Germany
T. +49 (0)7804 410 • www.bluline.de • info.bluline@etol.de